

CONTENTS

...

Development of the kayak	3
Structure of the kayak	16
The wooden framework	16
The covering	20
The fittings	26
The kayak rudder	31

...

DEVELOPMENT OF KAYAK

What did the Greenland kayak look like through the ages? Not much is known about the development of the kayak's form, structure, and materials. For the long period from the time of the settlement of northern Greenland by the Thule people till the middle of the 18th century, when the first written sources were found, we have to content ourselves with interpretations of a sparse material consisting of archeological finds.

These finds have been excavated from ruins of Eskimo homes and kitchen middens. As the material consists of waste matter and incidental things left behind, the information obtained from them remains incidental and incomplete as well.

A kayak is made of organic materials which decompose easily. As the framework and its parts are fragile, it is obvious that a 1-meter thick culture layer contains only broken and often unrecognizable fragments. That some individual fragments have been preserved to this day can be attributed to the solidly frozen ground and the dry Greenlandic climate contributing to preservation of organic materials such as wood, skin, and whalebone.

An evaluation of the few kayak remains dating from the oldest times, found in western Greenland, and their comparison with finds from northern Canada may give a vague idea of the development of the kayak's form but indicate practically nothing about structural details such as the appearance of the skin covering.

For a time, the Thule Eskimos "forgot" to use the kayak. They learned it again in the second half of the 19th century, at a time when the Greenlanders along the western coast of Greenland had developed the kayak to a type largely identical with the form known today.

The kayak introduced to the isolated Thule people represented a type used by the Eskimos of Baffin Island. We can thus claim that this was a repetition of the history of the time when the very first Eskimos migrated from the west, and it must be assumed that this fairly primitive kayak which corresponded to the quite limited hunting possibilities of the local Arctic conditions, gives an indication of the appearance of the oldest vessel forms used there.

Several assumptions have been made about an even earlier origin of these kayaks of the far Arctic. Theories have been put forth about cultural influence by Indians or inland Eskimos who migrated through the forests and streams of inner Canada to the coasts, changing their birchbark or reindeer-skin canoes to vessels covered with skins of marine animals. Also, it has been suggested that these vessels were eventually equipped with detachable decks against sprays, and that finally, to replace the detachable deck, they were fitted with a permanent deck installed in connection with constructing the rest of the vessel.

A feature pointing to the same direction is the single paddle, typical of a canoe, which was still used at the turn of the century by the Yukon River Eskimos in Alaska and which, as a matter of fact, was used together with the double-bladed kayak paddle even in the same vessel. Excavations involving the Ipiutaq culture existing in northern Alaska around the year 500 A.D. led to the unearthing of a toy kayak with a half-deck, which may, supported by the Greenlandic legend about deckless kayaks, back up the theory about a transitional form between the open canoe and the closed kayak type.

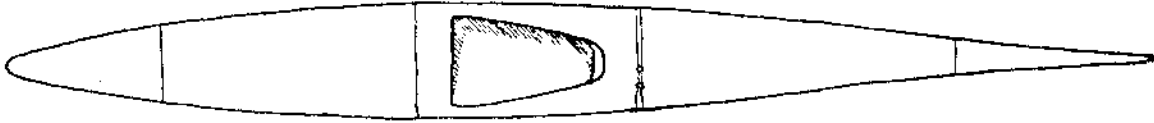

Fig. 1 Sketch of kayak type used by Polar Eskimos.

The above sketch dates from around 1900. It must not be interpreted as an illustration of the original kayak type of the Thule people, but as an intermediary form and a probable trend in the development. Its length, 5.3 m, is a little below, while its width, about 55 cm, slightly exceeds the respective measures of the regular western Greenlandic kayaks. It is, on the whole, a slightly heavier and clumsier vessel which, particularly with its open triangle-shaped cockpit, was not especially suited for the sea, since the vessel and its user did not yet form a water-tight whole. As far as the original type is concerned, we must assume that as its users were just beginning to practise hunting at sea, it must have been a simple and fairly stable vessel, with which it was possible both to venture out to the open sea between ice floes and to travel in the still fjords.

The individual kayak parts found in the Thule kitchen midden constitute a more concrete piece of evidence. These are stem piece, gunwale, rib, and deck fragments made of bone and wood. A deck beam assumed to have been situated just fore of the cockpit indicates a kayak width of only 40 cm which is considerably below the average width of the present western Greenlandic kayak.

Even though the Inugsuk excavations have brought to daylight more kayak fragments than those in Thule, the available material is not sufficient for a determination of the kayak form used during this period of development, with the possible exception of a small whalebone carving of a kayak profile unearthed in Inugsuk (Fig. 2). It may have been a toy for children, and



Fig. 3 Section of map showing parts of southern Greenland and eastern Canada, prepared by Resen in 1605 as a copy of Stephanus's map from 1570, here reproduced after a re-drawing dating from 1886. Original is in the Royal Library

water-tight skin covering, having the form of a weaver's shuttle. Length about 6 m, width 60–90 cm.

A report by Norwegian-born N.C. Geelmuyden, who functioned as a trade manager in Greenland in the middle of the 18th century, describes the Greenlandic kayak as consisting of many small pieces of wood covered by 4 sealskins. He mentions that the length of the kayak is from about 4.4 m to 5.65 m and its width about 47 cm. Geelmuyden further reports that the best kayakers were able to travel in seas rough to the degree that

UNEDITED TRANSLATION
For information only
TRADUCTION NON REVISEE
Information seulement



Fig. 2 Toy kayak, Inugsuk. Scale 1 : 2.

even if it is not a trustworthy miniature of an adult's kayak, it still unmistakably represents a kayak type. The protruding part in the middle either represents a man sitting in the kayak or perhaps, rather than that, a skin shield (short furcoat) covering the edge of the cockpit and the body of the man and indicating, if this assumption is true, a decked kayak.

This proof of the existence of the kayak since the 11th or 12th century is followed by an interval of several hundreds of years. The development and improvement of the kayak during these centuries can be traced only indirectly through the kayak and hunting tools unearthed. The first reliable pictures and descriptions of a kayak and the accompanying hunting tools date from around 1700.

The Copenhagen Naval Chart Archives have, however, a small elementary map drawn by Resen in 1605 as a copy of Stephanius's map from 1570. The map shows parts of southern Greenland and eastern Canada (Markland) and has two kayaks in it. One of these is carried under the arm of a Greenlander, while the other one is in water, with the man in it practising bird-spearing. Fig. 3 shows a section of the map. Although the general accuracy of the picture can be strongly doubted, the form of the kayaks seems to be in compliance with later evidence concerning its development. Structural slenderness and lightness are perceivable, and among noteworthy details are the sheer and the somewhat peculiarly rising stern end, known from some later and present types as well.

The oldest detailed description of the western Greenlandic kayak dates from James Hall's voyage in 1612: A spruce framework with a

barges and boats could not be trusted and even bigger (sail)boats were heaving. This was a recognition of the high degree of development achieved by the kayak as a sea-going vessel, with corresponding perfection of the using technique.

A number of wellknown and widely reproduced pictures quite skillfully drawn by Greenlandic artists, dating from a time shortly before and around the middle of the 19th century, include watercolors by Israil Nicodemus Gormansen and Aron from Kangeq, Godthaab Fjord. The kayaks depicted by the former artist have both ends curving up very strongly, almost in a caricatural manner, while the latter artist pictures vessels of a more unbending and controlled form.

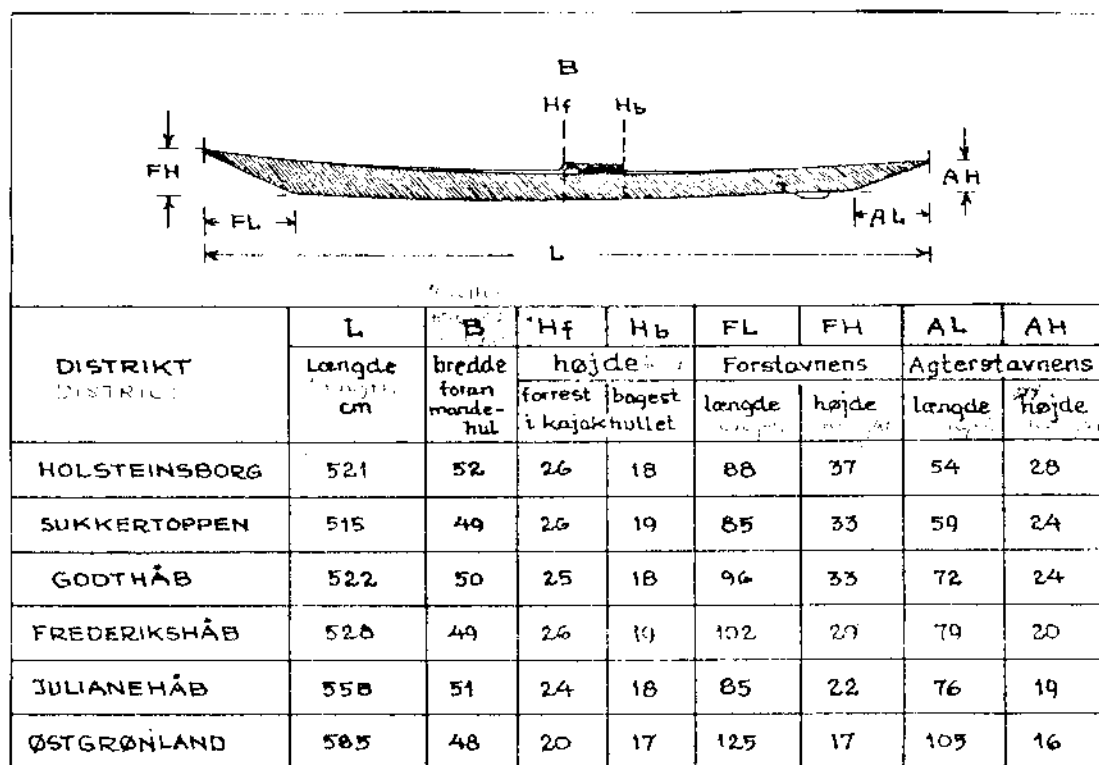

Fig. 4 Main measures of kayaks from western and eastern Greenland.

Fig. 4 summarizes the main dimensions of kayaks from western and eastern Greenland. The figures are based on information dating from 1915-1919. They represent average measurements from 3-5 kayaks from the main town of each district and outlying trading stations.

The above information is an extract of the somewhat sparsely available material concerning the form and appearance of the kayak in the course of its development. It is obvious that this is not a general time-related development but that it involves ethnically different designs occurring from northern to southern and eastern to western Greenland.

It seems that it was a common practice earlier to have sharply rising stems and especially sterns and that this trend has declined through an intermediary form in which only the stern had a rising end piece.

A stern piece curving upwards was earlier most common - and most persistent - in northern and central Greenland, but it has occurred on the eastern coast as well. A watercolor from 1830 picturing a colonial port in Godthaab shows kayaks with sharply rising sterns, and Gustav Holm has in his possession a drawing from the end of the 19th century picturing a kayak from Angmagssalik with the same characteristic stern shape but with a nearly level stem. It is almost impossible to find this form in Greenland today. Some reminders of it can be found in a few individual places. The photograph (Fig. 5) was taken in Qutdligssat in 1962. The curving stern of the black kayak can be seen on the right as contrary to the more traditional form and flat stern of the light-colored kayak above it.

As it is characteristic of the Greenlandic material culture not to produce useless or superfluous things, it is natural to wonder why the kayak had this slightly peculiar stern piece. This form may have been practical on occasions when the hunter, on his way towards open water,

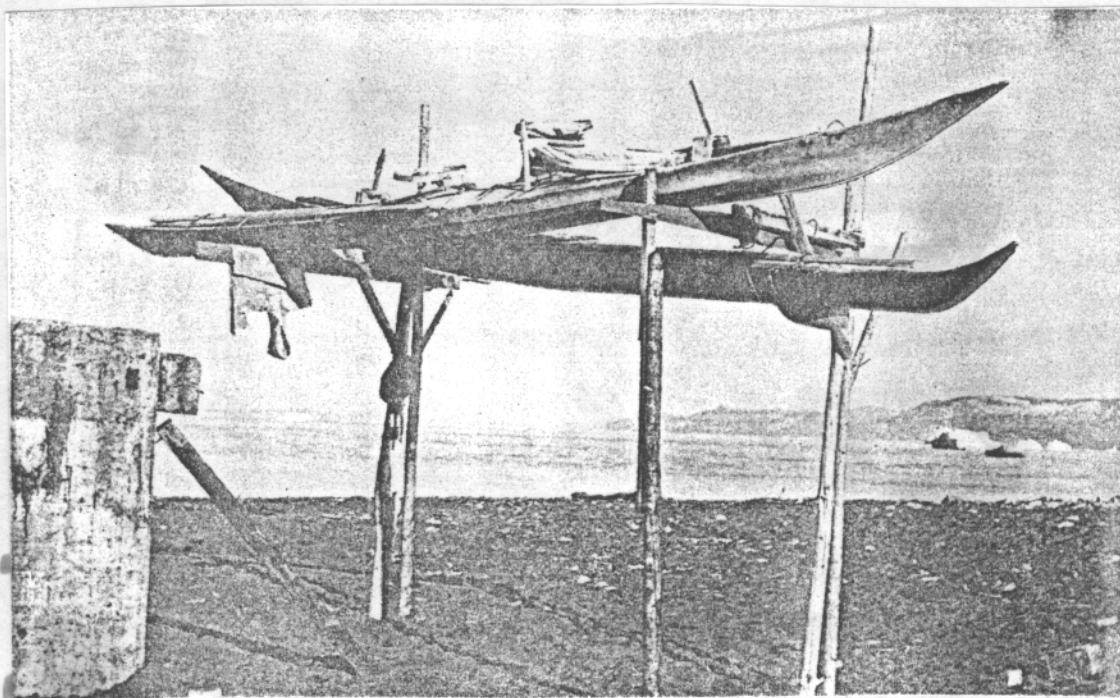

Fig. 5 Two kayak types, Qutdligssat, 1962.

travelled by foot on ice, holding the stem with his hand and dragging the kayak behind him. The curved stern piece could thus have functioned as a sleigh runner. It is also possible that the curved stern piece had a steering effect in the headwind, somewhat like a windvane, or that it otherwise had a stabilizing effect under certain wave conditions. The presently known keel under the kayak was first found around 1870.

Excluding this extreme form, differences between kayaks of northern, southern, and eastern Greenland are not immediately perceivable. It seems that central Greenland earlier used a slightly higher kayak with a prominent and well-proportioned sheer from stem to stern, while the more southern form was lower with an almost flat deck. On the eastern coast, the deck of the kayak is, if possible, even lower and flatter.

The cross-section of the central Greenlandic (high) kayak generally shows a rather angular profile with the 2 bottom sides forming

OPMÅLING AF KAJAK. KANGAMIUT 1959.

Målestok 1:20

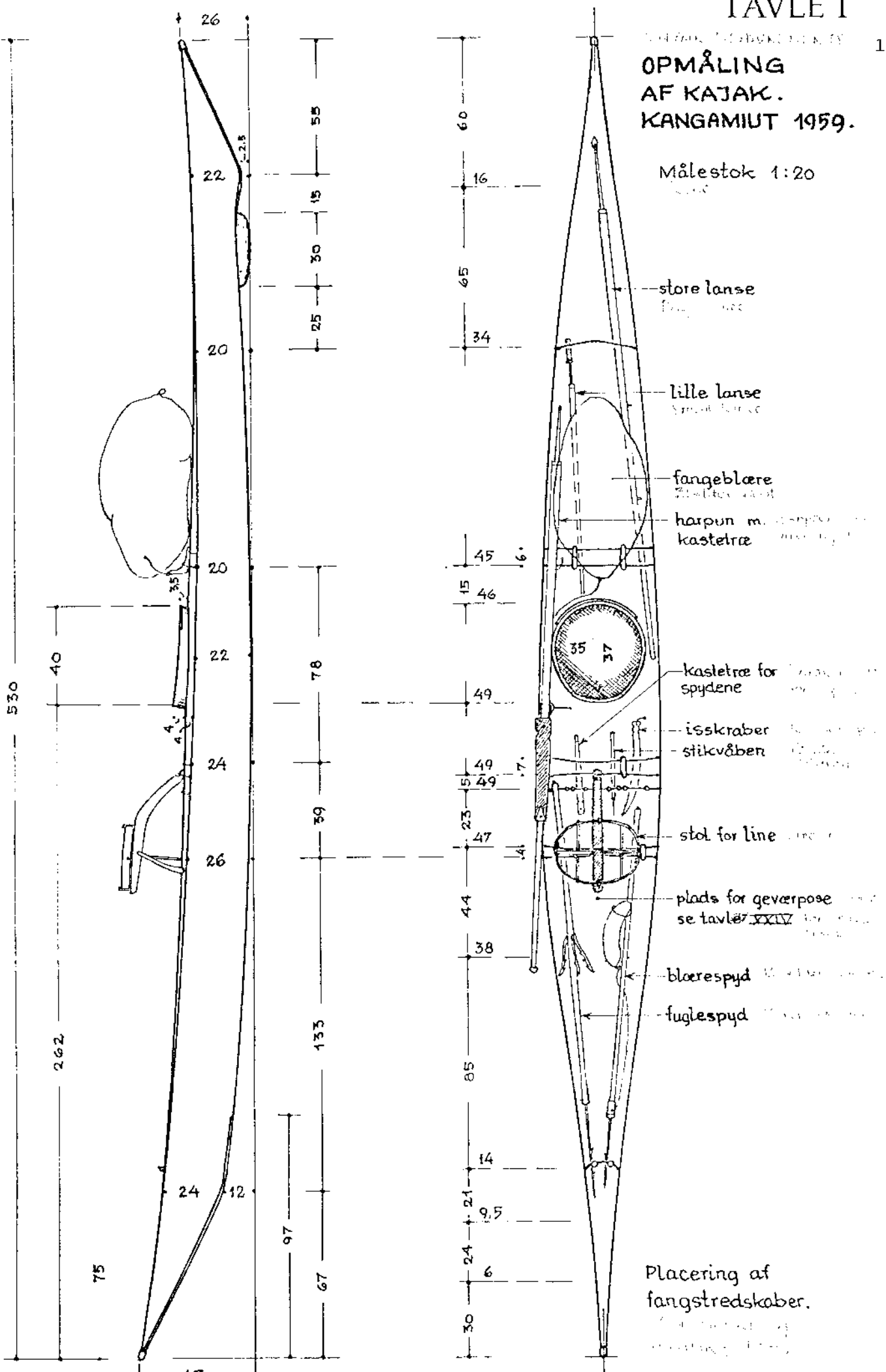

Placering af fangstredskaber.

an angle of about 160° , while the southern and eastern Greenlandic kayaks have a flatter, more rounded shape. Further, the stem and stern ends of the kayak (FL and AL, Fig. 4) are quite short in central Greenland, while they are much longer in southern Greenland.

Diagram 1 illustrates measurements of a kayak from Kangamiut. The kayak is rather high with a quite short stem and stern. The Greenlandic name of this kayak type is "imarsiut" (sea-going), since it can be used in rough seas for quite long times.

An examination of western Greenlandic kayaks, the number of which is small today, shows that it is difficult to determine definite local forms. The rapid social development resulted in migration from town to town and from trading stations to towns so that many types of kayak are met in one and the same place (See Fig. 6). The form of the kayak is influenced by local features and fashions, as well as personal requirements and trends. A good hunter is as a rule a good kayaker as well, and the better he is, the slenderer and smaller and better suited to prevailing circumstances is his kayak. On the other hand, as the importance of the individual hunter for the fishing industry is declining, the kayaks are built wider with flatter bottoms, which also happens when the kayaker suffers from kayak faintness, which is a balance disturbance comparable with sea-sickness.

A kayak must be "tailor-made" for the kayaker. There are no drawings or fully universal measurements; the length varies slightly with the height of the kayaker just as the internal width and the height correspond to his frame. When he sits in the kayak, his slightly bended knees and his toes must rest against the athwartships timbers of the vessel, to create a balance and contact between the man and the kayak.

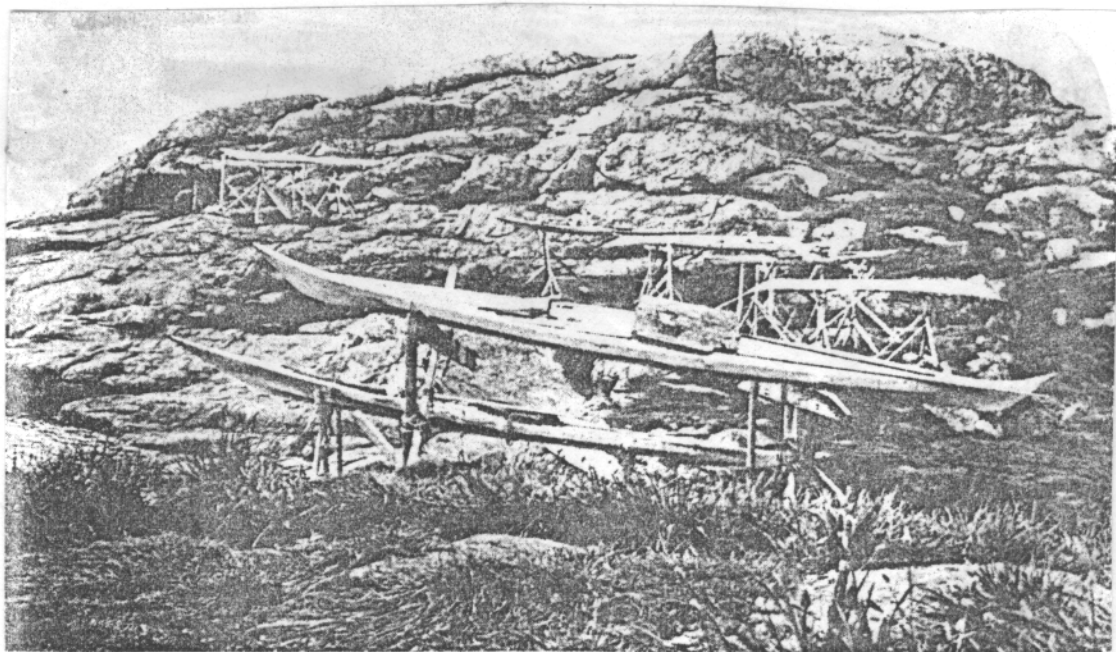

Fig. 6 Different types of kayak. Upernavik, 1955.

Thus, it is understandable that although the main shape of the kayak was determined by tradition, many incidental factors could contribute to the formation of the details. It was perhaps difficult to acquire framework of correct dimensions and length, or the kayak-builder may not have possessed the required cleverness or patience, and later he may have lost the traditional skill characterising earlier generations.

Diagrams II and III show kayak measurements from Egedesminde and Frederikshaab respectively.

Earlier it was thought that a hunter should have two kayaks, one for summer and one for winter. The winter kayak was to be as light as possible, as it was often necessary to carry the kayak for long stretches on the ice to get to open water or to lift it over pressure ice. These difficulties constituted such an indispensable part of winter hunting, that a hunter carrying his kayak on his head is denoted in Greenlandic with a special word, "maqigtoq".

OPMÅLING AF KAJAK. EGEDESMINDE 1960.

Målestok 1:20

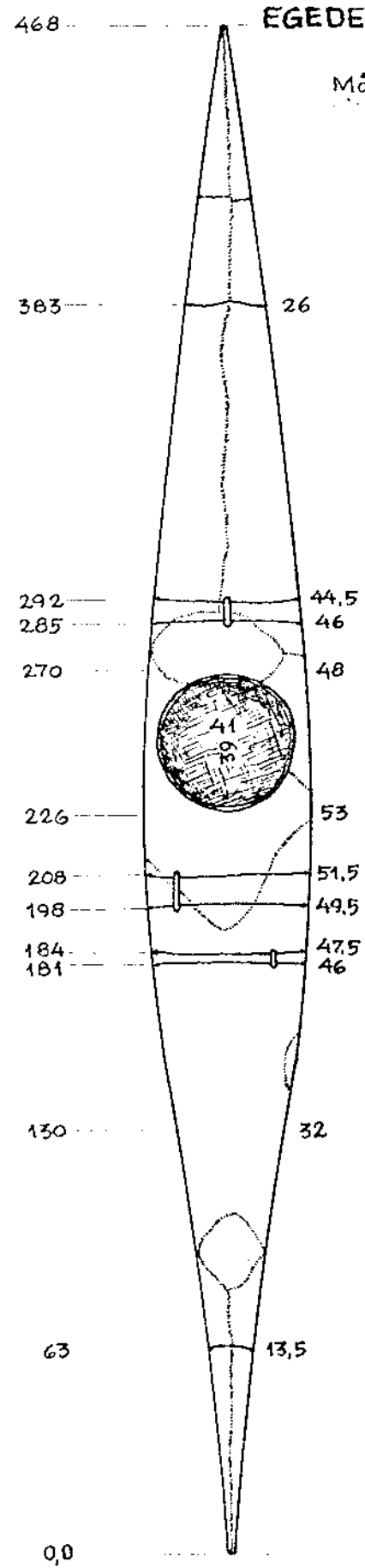
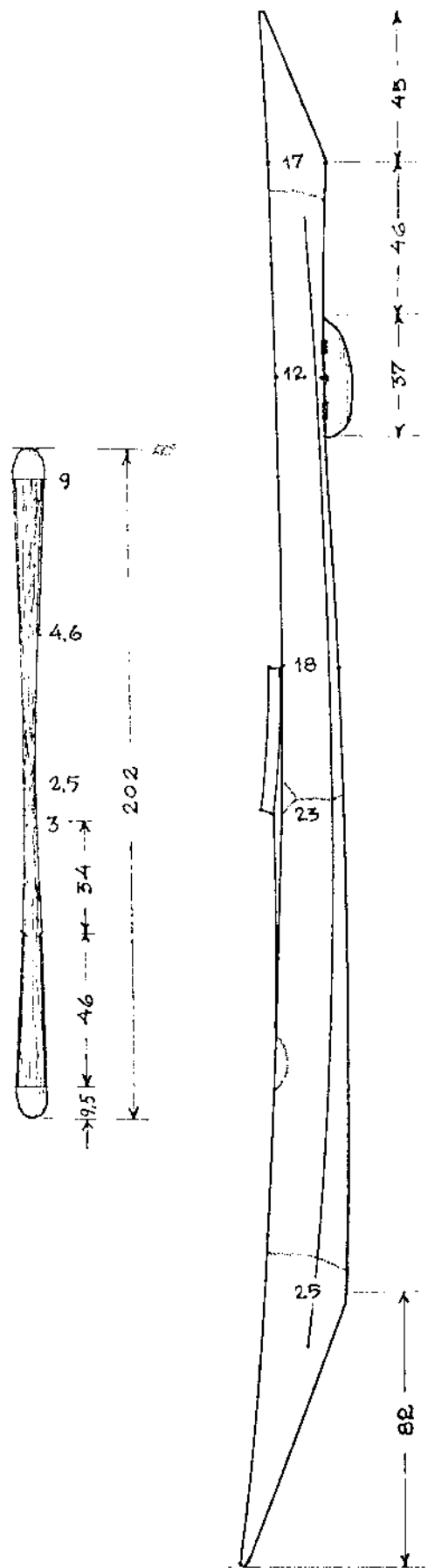

OPMÅLING AF KAJAK.
FREDERIKSHÅB
1960.

Målestok 1:20

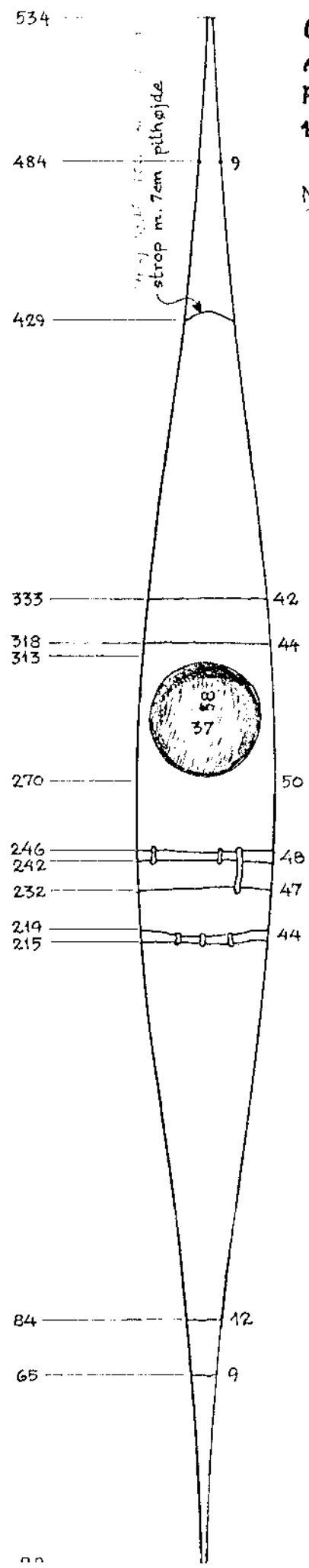
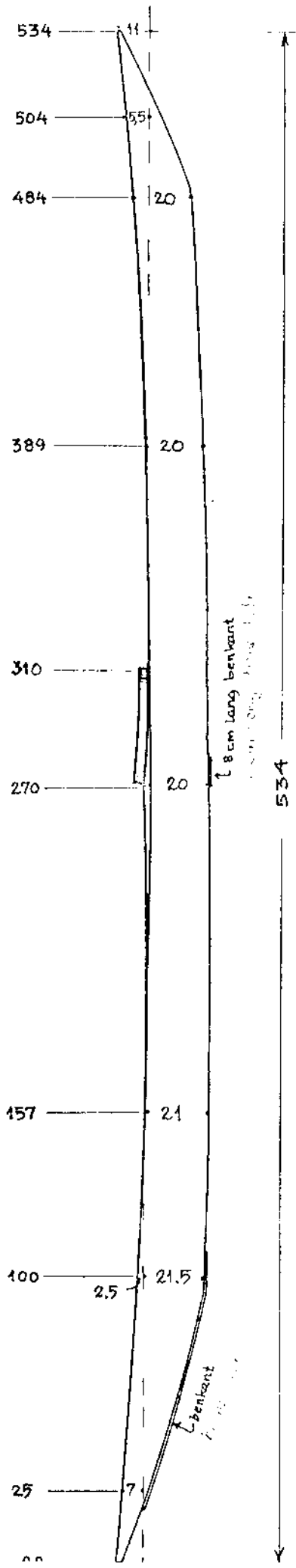
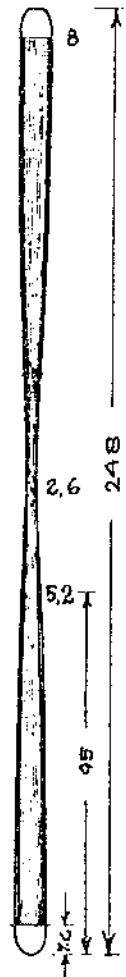

Besides these mainly external and visible differences in shape, there were other, just as interesting differences in the construction of the wooden frame and its skin covering.

CONSTRUCTION OF A KAYAK

The wooden frame

Diagram IV (at the end of the book) illustrates a kayak frame from Frederiksdal, southern Greenland. It is a slender and quite flat type with very little sheer towards the ends.

The framework is built of wood which must be light, pliable, tough without essential knots, and of suitable length. Greenland has no forests, but it has always been relatively easy to find suitable driftwood, which comes from Siberia, northern Canada, and Alaska, floating with the northerly streams into the Arctic Sea and further with Polar streams south along the eastern coast of Greenland and up along the western coast. This is wood from coniferous trees such as pitch pine, Oregon pine, the finest old pines, and quite thick stems occur. The species are *Larix* sp., which is reddish, and *Picea* sp., which is lighter both in weight and color. It must have been a very slow process to saw or split these stems to usable dimensions, but time may not have played an essential role in a Greenlander's life.

Today, only imported pine and spruce are used. They can be purchased from the stores of the Royal Greenland Trade Department all over Greenland. Fresh wood is preferred because of its pliancy. The wood is used for the keelson, the side stringers and the gunwales which, together with the stern and stem pieces constitute the main structure and determine the basic form.

The ribs and athwartships parts can naturally be made of driftwood or commercial timber as well, but local willow was preferred especially in earlier times, or, if available, wood from a juniper. The Polar willow grows in many places in Greenland, reaching in protected valleys the required height of a few meters, with 4-5 cm thick trunks that can be split.

Jacob Danielsen (1888-1938) reports how his father used for ribs the wooden hoops of a barrel and how he used to chew them to make them pliable. Building the kayak framework was men's work. According to a time-honored practice, every hunter would make his own kayak as well as one for his son when the latter would reach the age of 12. However, some skilled kayak-makers undertook the task of building kayaks for others, and also, local municipal boards sometimes granted minor subsidies to have kayaks built for fatherless boys. A report from 1874 mentions a hunter who was invited to spend a winter in an alien village and during that winter built four kayaks.

Building a kayak normally requires about 100 hours, a period traditionally regarded as a festive season during which special foods are offered to motivate local people to participate in the work.

Stem and stern structures demonstrate the most noteworthy constructional differences. Fig. 7 shows three variants, 2 of them illustrating a particularly interesting detail, an athwartships support piece making all parts lock into one another by means of wooden dowels and lashings. The Sukkertoppen stem does not have a support piece, and its keelson, stem piece and gunwale are tied together with lashings alone. This construction method is probably the simplest and the original one, although it requires a very precise fit of the contact surface and very strong and taut lashings.

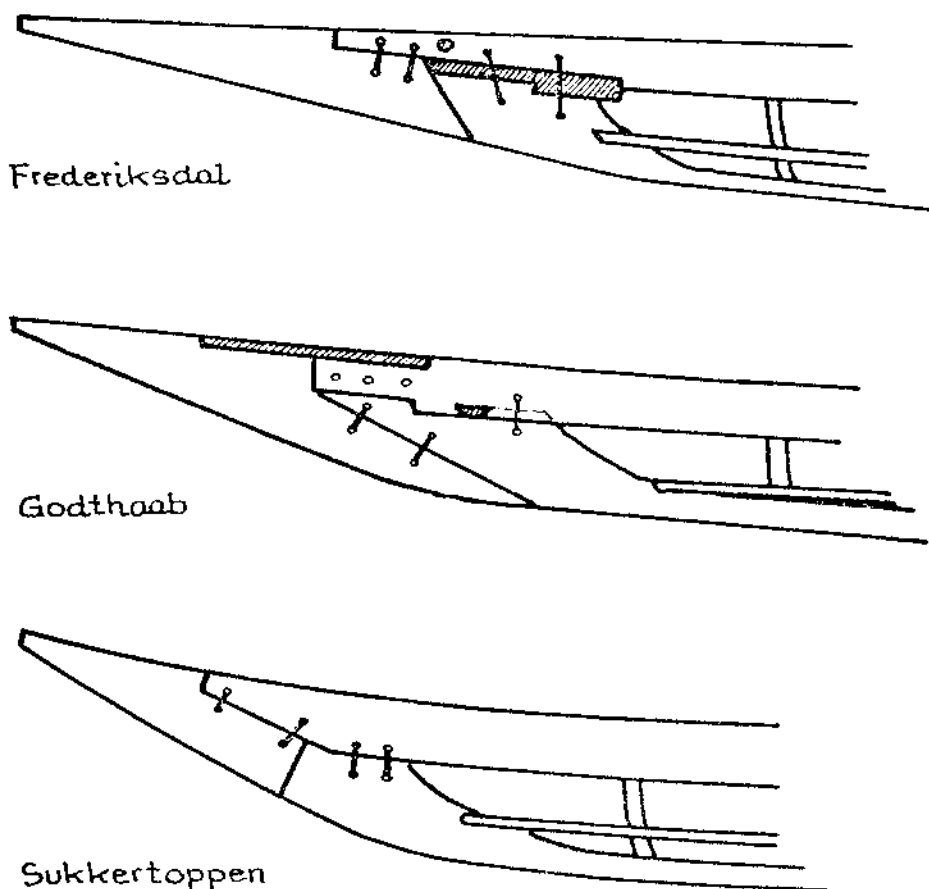

Fig. 7 Construction details of kayak stems.

The Frederiksdal kayak plan, Diagram IV (at the end of the book) shows a stem and a stern not built in an identical way, although the principle is the same. Corresponding differences occur in the other illustrated kayaks as well.

Greenlanders were masters of the lashing technique, and lashing was not a substitute for other construction methods. It was necessary to join the pieces together by a strong but still elastic method that could be used for kayaks, umiaks, sleighs, and hunting tools. The kayak framework had to respond to the pressure of the waves without breaking or splitting.

The lashings were made of thin sealskin strips and earlier of baleen as well.

To construct a kayak by lashing is undoubtedly the oldest method, still preferred in northern and central Greenland. South and east Greenlanders mostly notch the wooden pieces into each other and particularly prefer to fasten the ribs to the gunwales by mortise joints that may be locked by wooden dowels. If wooden dowels were used, they were additionally secured with small wedges hammered in. The use of tenons and dowels can with certainty be attributed to an influence of colonial period carpentry.

Just fore of the cockpit of the kayak there is a characteristic wide and curved forward cockpit deck beam ("masia") (See Diagram V), which connects and holds together the gunwales. The deck beam is sawn from one piece of wood, with the underside cut on the slant to facilitate entrance into the kayak. Besides, the underside of the forward cockpit deck beam may have handles for carrying the kayak. This is a special Greenlandic feature known from one of the first cultural stages, and it occurs in the Angmagssalik district as well. Further, deck beams may be longitudinally reinforced both fore and aft of the cockpit. These reinforcements were needed to support the line rack^{*)} and tools fore of the cockpit and captured seals, birds, etc. aft of it, as well as for carrying an extra passenger who would sit aft, his back to the back of the kayaker.

Further, the wooden parts of a kayak include the coaming hoop. It is not directly connected to the framework but forms a kind of fastening place for the skin covering. It is a quite thin, about 6-7 cm high wooden framing bent into a circular form, with a circumferential rim at the lower edge for fastening the skin.

^{*)} Translator's note: Line rack = framework on a kayak for holding hunting gear (Vinterberg & Bodelsen; Danish-English Dictionary, Gyldendal, 1976)

On the external side of the upper edge and, as a rule, only around the aft half of the coaming hoop, is attached a similar rim of wood or bone. The remaining part of the edge may be equipped with decorative small bone buttons for fastening the kayaker's full- or half-length furcoat around the coaming hoop. This is an important detail securing a water-tight combination of kayak and kayaker. In olden times this rim may have consisted of whalerib shaped and finished as described.

All wooden kayak parts have their own specific Greenlandic names, which vary to some degree between northern and southern Greenland. These are shown in Diagram V.

Even though no drawings or instructions were available for building a kayak, the course of the work was traditionally bound to a certain technical process. First, the gunwales and the deck beams were manufactured and assembled. The second stage consisted of the shaping and installation of the frame and the laying down of the keelson for the "deck profile" of the first stage. The third stage was made up of the manufacture and lashing of the special stem and stern pieces. During the last stage, holes were bored in the gunwales for the athwartships straps and lashings for the rudder and the harpoon rest.

Kayak covering

The use of animal skins for housing, clothing, vessels, etc. has played a decisive role throughout Greenlandic cultural development. Thus, skin processing methods have been brought to a perfection that even with the simple tools and means available, is comparable with the results of modern tanning methods.

DE GRØNLANDSKE BETEGNELSER PÅ KAJAKKENS TRÆSKELET.

THE GREENLANDIC NAMES OF THE KAYAK'S WOODEN FRAME.

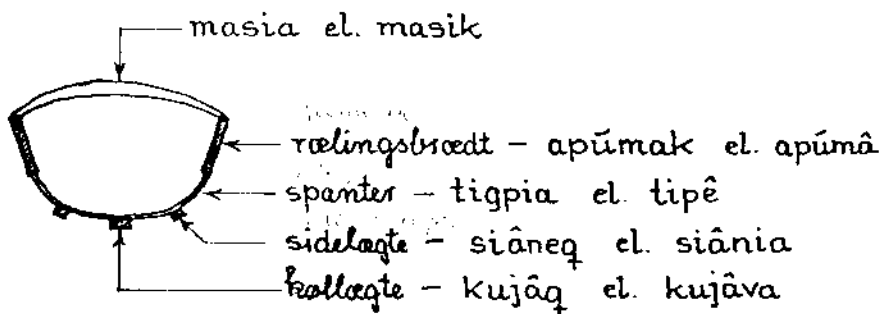
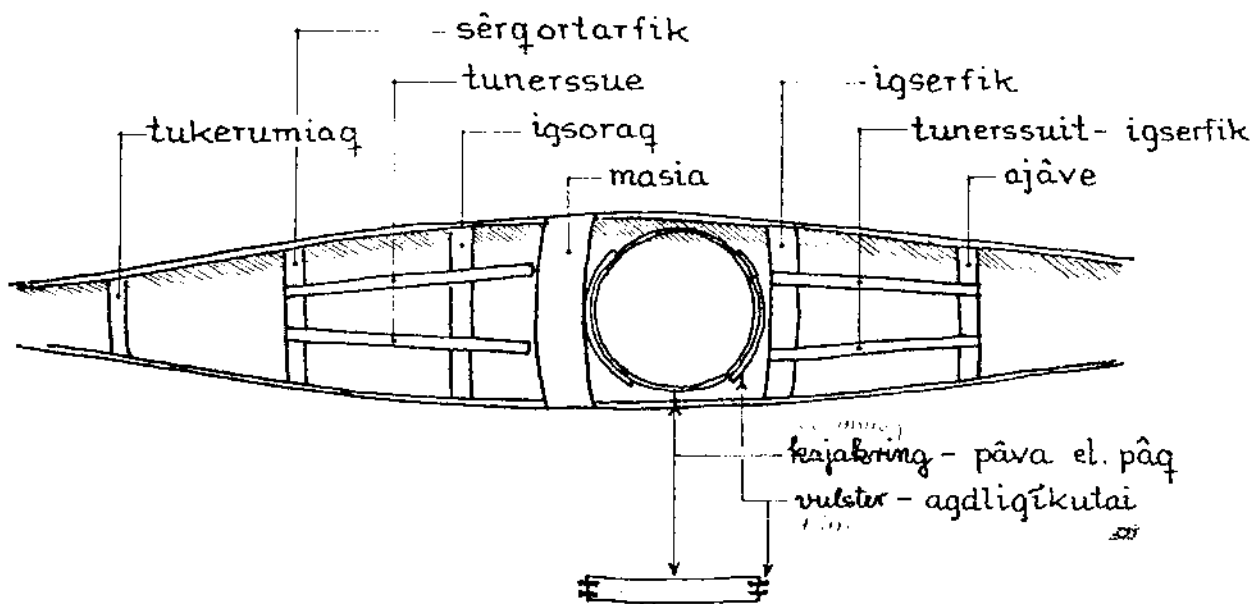
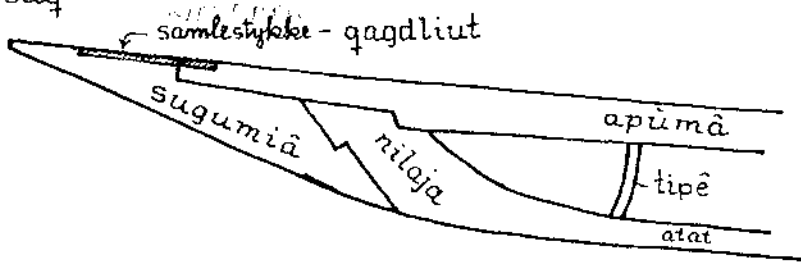
forstavn
usússaqagterstavn
kinguata usússâ

Greenlanders use sealskins to cover their kayaks, and there is little variation in the choice of seal species depending on location and catch possibilities. As a rule, western Greenland prefers the skin of the adult harp seal, also called "blackside", in Greenlandic "ataq", the adult length of which is about 2 m. This species is called, during its younger stages, "blueside", until it acquires the two longish black spots on its sides and a black face. Males of a special "dark blackside" type develop as adults larger combined black areas and their skin is considered stronger than that of the common "blackside". The dark skin of the hooded seal and sometimes the skin of the beluga were alternatively used in earlier times.

Skins of bearded seals are used especially in the Angmagssalik district. These are so big that usually two skins are enough, while four harp seal skins are needed to cover a kayak. Tales about Aron from Kangeq report that he was a tiny man with a kayak so small that it could be covered with three harp seal skins.

Processing the skins was women's work. The tanning agents consisted of simple things such as ashes, blood, and urine, and extracts of different plants were used for possible dyeing.

After the animal is skinned by means of the "ulo", the well-known Greenlandic women's knife, it is scraped clean of fat. Scraping and softening are an important process requiring a knife that is not too sharp. That a great number of small scrapers have been found among the stone tools of the earlier Eskimos is a proof of the great importance of processing skins, and the usability of these small stone scrapers is reflected in the fact that some older women still prefer a scraper made of a piece of stone.

Skins for kayaks can be processed in two different ways. One of the methods, in which the external membrane is preserved, produces a dark

skin, "erisaq", which is very durable, while the other method, in which the membrane is removed, results in a light but not as strong skin, "uneq".

The dark skins are treated in the following way. The fat is removed, the skins are scraped and placed in urine until the fur can be removed. They are removed from the urine, rubbed with ashes, and the fur is taken off. In older times, the fur was removed with a little bone knife, "erisaut". The skins are washed and dried without stretching them. When they are taken into use, they undergo another process with washing, rubbing, and stretching. Finally, they are soaked in saltwater for a few weeks which makes them so elastic that they can be stretched until double in size, whereafter they are ready for use.

The light skins are placed wet in a bag or buried in the ground until they reach an initial stage of rotting, when both the fur and the external membrane can be easily removed. The subsequent treatment is the same as with dark skins. Both skins are rubbed with fat during use.

These two different processing methods do not indicate any cultural differences. They indicate only different practical circumstances. In earlier times, and especially in districts with abundant catches, the women may have been unable to undertake a time-consuming process such as making dark skins, and in expectation of further abundant supplies, they resorted to the less durable and less time-consuming light skins.

It must be mentioned as well, that in northwestern Greenland and around Angmagssalik, hunters residing or commuting in inner fjords used dark skins, as they would better match the dark coasts and thus be less conspicuous. Southern Greenland used mostly light-colored vessels which possibly can be attributed to hunting among field ice.

When the Greenland Folk Art Society had a kayak built in 1967 in Godthaab for the World Exhibition in Montreal, skins and sewing equipment had to be borrowed from other places, as more than 20 years had passed since the building of the last kayak in Godthaab. Only a few older men and women were found who still mastered this old Greenlandic skill, although they no longer practised it.

The lack of skins for kayaks has become a problem not alleviated by rising wholesale prices and international demand. Furthermore, seals can be hunted today by other means than kayak. As the skins for a kayak cost about Dkr. 200 (around 1965), it is no wonder that a hunter chooses to use canvas which can be bought for half the price.

A skin covering is stronger and easier to repair than a canvas covering but has to be regularly treated with grease which at the same time impregnates the wooden frame. Today, the skin covering is sometimes treated with white oil-paint instead of grease. However, a layer of impregnating paint on the seams alone is more frequent. Thus, the irregular and diverse painted seams, especially those on top of the kayak, form a characteristic decorative pattern (See Diagram II).

The canvas covering is painted and easy to maintain by fresh coats of paint, but it is more vulnerable and inclined to split and break and more difficult to repair in an emergency. As the canvas is not elastic, it does not respond to the movements of the wooden framework, and the seams are the weakest spot requiring broad overlaps (Fig. 8).

Sewing the skins on the kayak as well as their processing are tasks belonging to women. The washed and stretched skins are cut obliquely from one front flipper to the umbilicus and sewn together end to end. Any further cutting is mostly done by rule of thumb, and the skin of the head

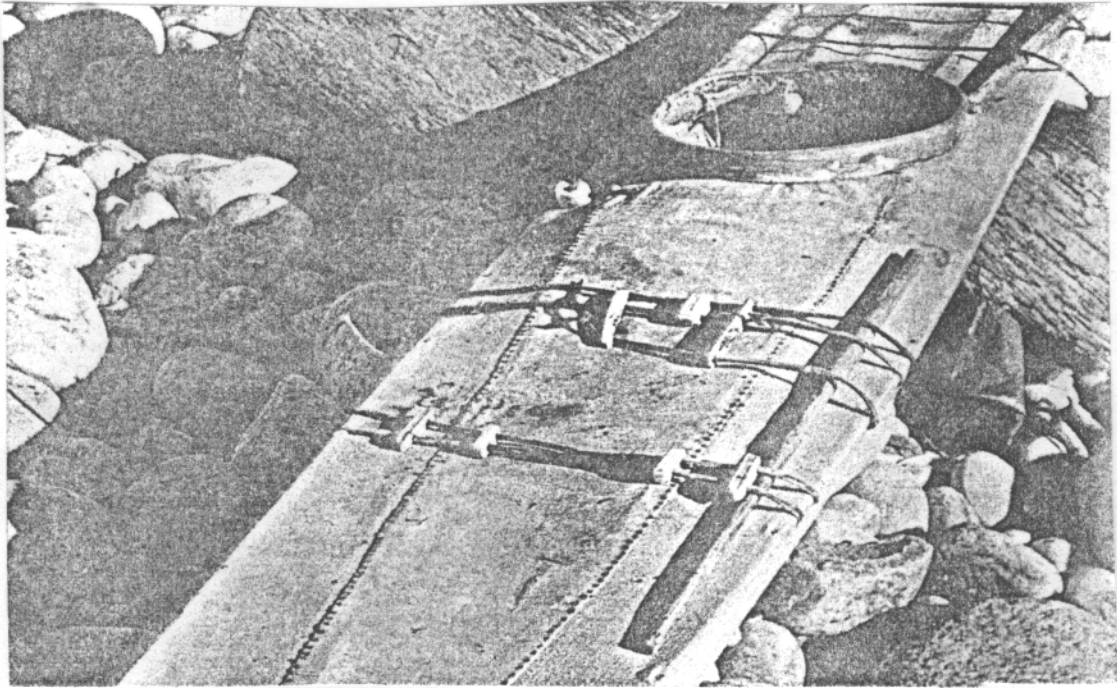

Fig. 8 Kayak with canvas covering. Godthaab, 1955. Note the very wide and flat shape as well as the cross straps with connecting pieces of bone and the characteristic harpoon rest (See Diagrams VI and VII).

and the flippers usually constitutes the only part that is wasted.

The sewn skins are stretched over the kayak frame, which is done by men, since it requires strength to produce a taut stretching. At the same time, the women lace and tie to fasten the skin to the frame until the actual sewing begins. The lacing is done with very strong braided tendinous fibrils, while the strong and long neck, back, or tail sinews of beluga or narwhal are used for the sewing. Sometimes reindeer sinews are used. The sinews are unravelled, rolled out, twisted, and braided to various thicknesses. Very long stretches of sinew have to be braided together for sewing kayak skins to avoid knots in the most important seams. The sinews have the advantage of being water-absorbing so that they swell and fill the sewing holes making up a watertight seam.

It is preferable to go on sewing until the whole kayak is covered. The fore part of the kayak is covered from the stem to the cockpit and the aft part from the cockpit to the middle and from the stern to the middle. Sewing aft of the cockpit is to be carried out with special care as this part must be able to carry the catch. Therefore, this job, together with the final sewing around the kayak and the fastening to the coaming hoop, is performed by the most skilful women.

When the skin dries around the kayak, it shrinks and becomes taut like a drumhead, making the wood yield a little, which gives the kayak its strength and pliancy. For the same reason, the kayak has to dry after each use, to be ready for the next launching. A kayak is normally rigid to the degree that it can be used as a bridge to cross over rifts in ice.

The fittings of a kayak

As the sewing is carried on, the vital straps are fastened athwart the deck. Their number and location may vary a little. Diagrams II and III show, however, that there is a standard pattern corresponding to the main objective of the straps, which is to hold the hunting tools in their place. Further, the kayak straps serve as an attachment for the line rack and the tow equipment for the catch. The kayak straps, "tarqat", must be strong. They are manufactured from sealskin used for making straps (the same that harpoon lines are made of) or from the skin of newborn walrus calves. The task of fastening the straps to the framework belongs to men. The straps have to be fastened so tight that the whole kayak can be lifted up by just one of them.

The straps are equipped as a rule with small pieces of bone or teeth, "qorutit". These are placed like beads on a string. They can be

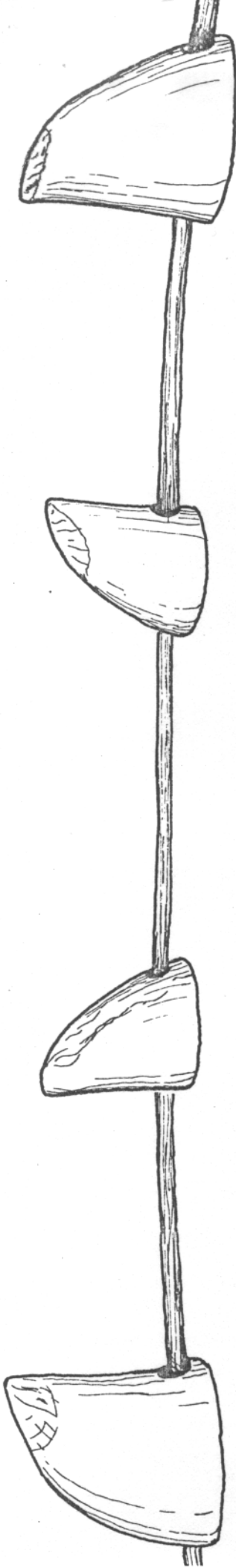

STRAP WITH SPERM WHALE TEETH
SNOR MED KASKELOTTÆNDER - 1:1
GODTHÅB 1955

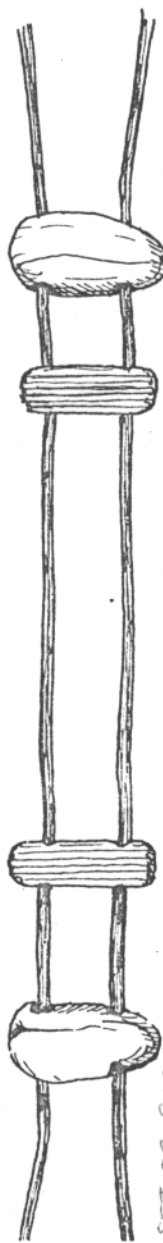

SET OF STRAPS WITH CONNECTING PIECES MADE OF WALRUS TUSK
NORESÆT MED SAMLESTYKKER AF HVALROSTAND - 1:2
GODTHÅB 1955

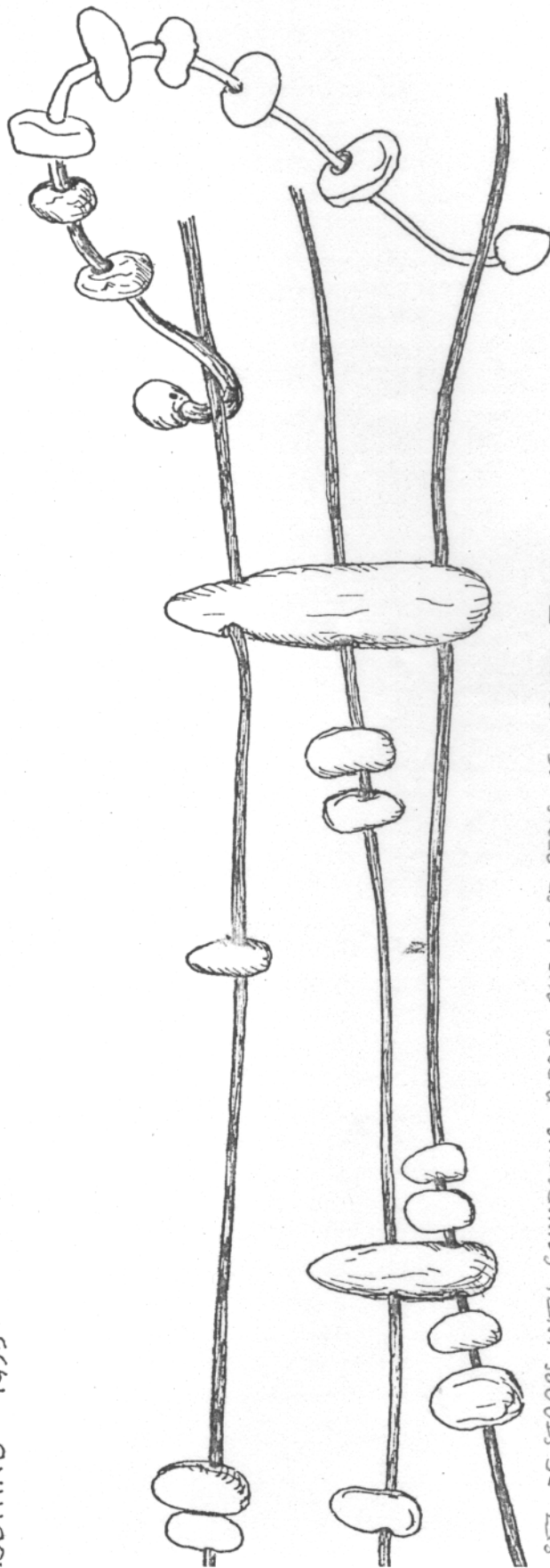

LOOSE CHAIN FOR
LØS KÆDE FOR
FASTHOLDELSE
AF HARPUN
FASTEVING
HARPOON

SET OF STRAPS WITH CONNECTING PIECES AND LOOSE BEADS OF WALRUS TUSK
NORESÆT MED SAMLESTYKKER OG LØSE PERLER AF HVALROSTAND - 1:2
GODTHÅB 1958

shuffled to and fro so that they serve as supports for tools, while their original function is to keep the straps at some distance from the deck so that skin does not rub against skin and spray water does not gather on the deck but dries freely. The oblong pieces or blocks have holes in them and usually travel along two straps, but sometimes long pieces with three holes for three straps can be seen. The straps can be adjusted to the required tautness by moving the bone pieces.

The imagination and artistic talent of the individual hunter is expressed in these bone beads and pieces. Almost all of them have a decorative finish and a smooth, nearly polished surface. Some of them have a groove pattern. Some of these beads can be seen in Diagram VI.

A Godthaab strap (Diagram VI), used as the foremost cross strap, runs through spermwhale teeth which show a lavishness in the choice of material but constitute at the same time a good support system, with their vertical sides facing each other.

The clever Sydproven strap set includes a loose chain, the terminal beads of which are attached to the straps with small bone pins.

In some locations in central and southern Greenland these bone pieces were earlier shaped in the form of stylized animals such as bear, seal, grouse, fox, beluga, Greenland halibut, etc. They were regarded as amulets bringing hunting luck.

The bone piece serving as a rest for the harpoon (Diagram VII) was frequently shaped in a special and meaningful manner. The harpoon is normally well fastened to the fore and aft deck straps during paddling, but when the hunter approaches his prey, the harpoon has to be ready for immediate use while resting on the kayak. It is loosened and placed so that its tail end rests in the half-circular impression of a special piece

of bone fore and right of the cockpit (See Fig. 8). This piece is shaped with very particular care, and the right, or external, side of the piece is often made higher to further protect the harpoon against falling out. The underside is curved to fit the curvature of the deck. Many shape variations occur among the earlier finds of harpoon rests made of bone, wood, and baleen.

Eskimos of the Thule region used to install a small holder right in front of the cockpit on which the kayak paddle could rest in an athwart position while not in use.

Sometimes the very ends of the kayak are protected by a small piece of bone, "usûssaq", fastened with pegs. These end protectors undoubtedly have a practical value, but some individual versions of the same - those with a small bead on top of a bigger one - may seem superfluous and purely decorative. However, this version is probably the last stylized reminder of an earlier, infrequently occurring custom: To give the protective piece in the stem end the shape of a seal in an erect position, looking forward.

A bone list protected the keelson and the stem and stern pieces. It had to be strong, pliant, and workable, and therefore, the ribs of the humpback whale were earlier considered the best material for it. The list was made of strips about 1 cm wide, and as it was not possible to find strips as long as the kayak, several pieces were joined by bevel cuts with the overlaps pointing aft. Frequently only the stem and stern pieces and the forefoot were protected. The list is placed on the outside of the skin covering and fastened to the keelson wood with small bone pegs through holes in the list, after the kayak is otherwise completed. If this work is carried out with great care, one end of each peg is split, and a small

Harpoon rests
HOLDERS FOR HARPUN
agssagikut

Målestok 1:1
Scale

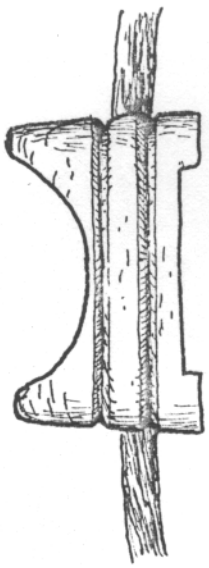

IKERASAK (HBG)

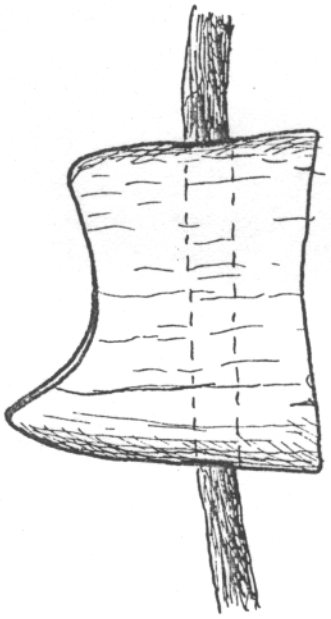

IKERASAK (HBG)

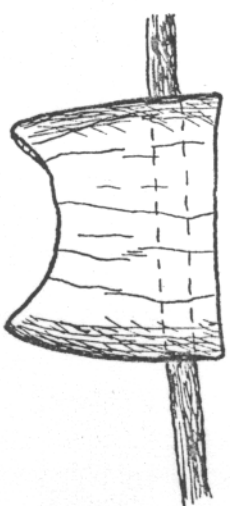

GODTHÅB

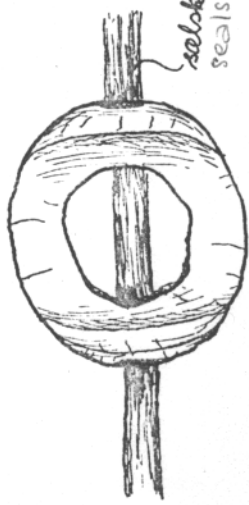

selokindsstrop
sealskin strap

wooden wedge is hammered into the split.

The completed kayak weighs about 20 kg.

The kayak rudder - "aqût"

The introduction of firearms into hunting by kayak necessitated another - and probably the last - improvement, which was the rudder.

The kayak rudder (or keel) was not invented until the end of the 19th century, even though shotguns and rifles had been known and used long especially for hunting on land. Until around the 1870's, it was not a common practice to shoot from a kayak. Shooting was carried out from a suitable rock or perhaps an ice floe.

The muzzle-loading guns of olden times were not suited for shooting from the kayak, and it must have been a difficult operation to load one in the narrow vessel. Another, perhaps even more important restriction was that it was necessary to shoot longitudinally to have a longitudinal kick-back. Side shots certainly resulted in capsizing of the kayak.

The original harpoon-throwing technique consisted of a combination of the vessel's course directly towards the target and the movement of the arm. This situation is called "piortoq", a word also used to describe a falcon diving vertically for its prey. From the moment the kayaker ceases to paddle until the harpoon is cast, the kayak must travel by itself, exposed to the wind and the waves. However, in the short time required for grabbing and casting the harpoon, no major deviations from the main course can take place. On the other hand, to take out a gun, aim, and shoot is a much slower process, during which the kayak may change its course. Therefore, it was necessary to invent something to maintain the course under the new circumstances, and the solution to this problem was the discovery and development of a rudder.

The Greenlandic name for kayak rudder is "aqût" or "aqûtâ". The same word is used for a ship's rudder, which discloses the origin of the idea. The first experimental rudders had the form of a ship's rudder and were placed accordingly at the stern end of the kayak. This invention is attributed to a large-scale hunter, Jens Reimer, who was born in 1824 in Jakobshavn. First he experimented with a long thin rope floating behind the kayak. As this was of no use and rapidly sank into the water, he manufactured a thin wooden plate about 34 cm long and 14 cm wide and tied it to the kayak's aft end like a ship's rudder so that it was partly above and partly under the water. This arrangement was not satisfactory either. The rudder made a noise in the water, and it was difficult to tie it on securely enough to prevent it from wobbling and getting loose.

Nevertheless, the enthusiasm to experiment was catching, and hunters started to imitate Jens Reimer. As they were not able to produce a very good rudder, they placed it under the kayak out of mere bashfulness, and thus, gradually, the best solution was found, the one that is used today. The submerged rudder was thus discovered and first used by hunters in Disko Bay around the trading station of Rodebay north of Jakobshavn.

Originally the rudder was fastened with ropes encircling the whole kayak, and experiments were made with different tying methods. In the Umanak district attempts were made to tie the ropes to an athwart stake placed on the kayak - a method that was rejected soon. At the Ikerasak trading station south of Holsteinsborg kayaks were built with a strongly protruding keel situated under the skin covering immediately in front of the stern piece, bulging out in a half-circular form. That the "bulging rudder" has not been satisfactory is proven by the fact that the same type of kayak was later equipped with an additional rudder of the

common type, fastened aft of the bulge.

The rudder did not seem to achieve a final or uniform shape, which can be attributed to its emergence at a late timepoint when the cultural development was influenced by many, more significant factors. The rudder was known and used in some places until it disappeared only to be reintroduced later. In some districts it was used rarely, and today some of the kayaks of a community have rudders and some do not.

The lower diagram of Fig. 9 shows the most frequently occurring, well manufactured standard rudder. The rudder, having a flat, widened upper edge resting against the keelson, narrows towards its lower rounded edge. It frequently has a hole in the centre. The hole was supposed to make the kayak turn easier during paddling without otherwise reducing the steering effect of the rudder. The two cuts in the upper edge of the rudder are in this case fitted with a bone piece, "aqûserfik", to resist wear and to provide support for lashings. As mentioned, the rudder was either fastened with ropes around the kayak or lashed through small openings between the wooden keelson and the bone list. The rudder must not be too stiff to yield when the kayak touches the bottom or encounters ice.

The upper diagram of Fig. 9 shows a more refined kayak rudder. It consists of two parts, which are very carefully attached to each other by two tenons so that longitudinal sliding movement is prevented while the rudder can bend sideways due to a joint between the two pieces.

Besides the stability provided by a rudder in connection with the use of firearms for hunting, it must be assumed that the rudder has a stabilizing effect against sidewind which normally hits strongest the aft part of the kayak, especially when the inflated bladder float is placed on it.

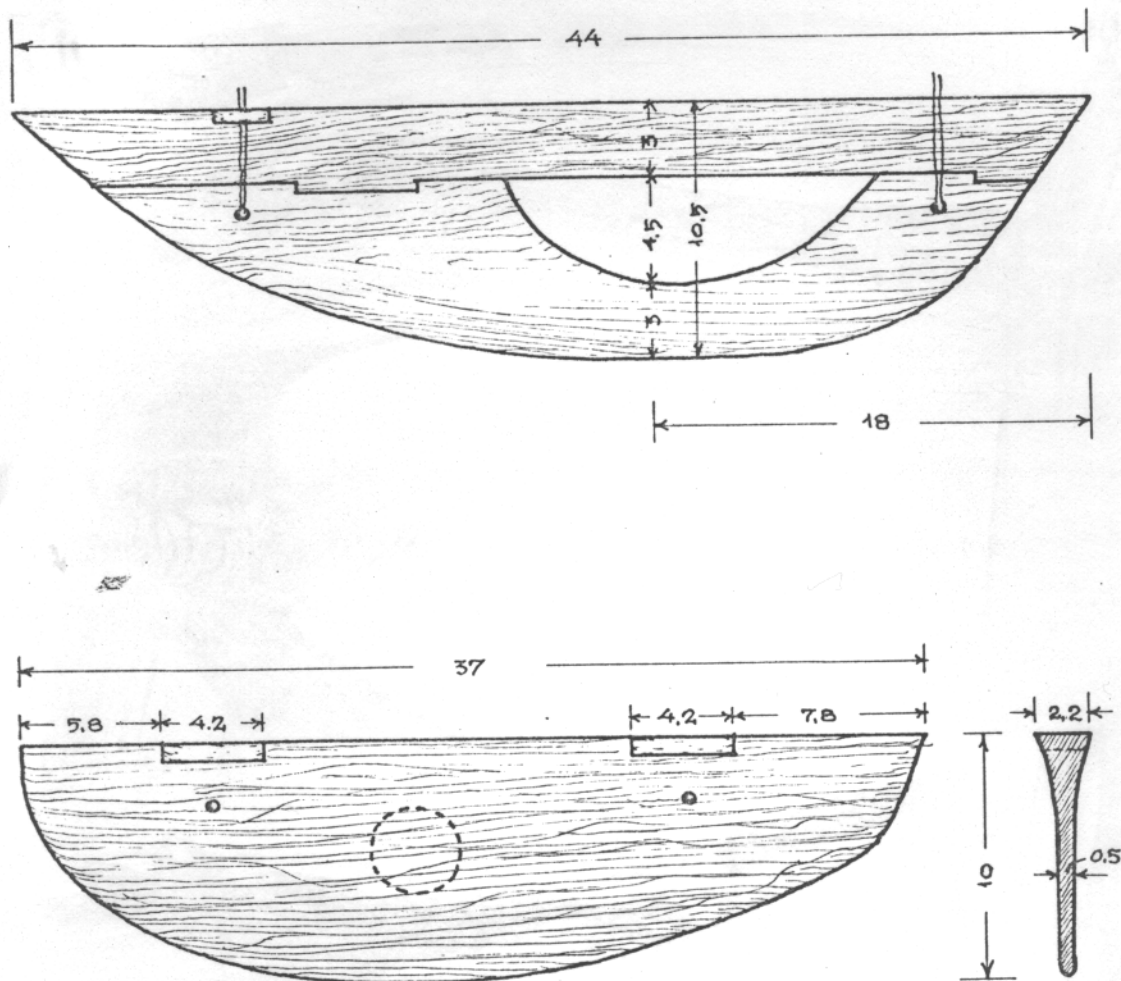

Fig. 9 Two kayak rudders - aqût. Egedesminde, 1960.

Today's kayak is the final product of experiences of many generations. The kayak was established for hunting and transport in open water, and its design has shown no change for the last 100 years. However, now that perfection has been achieved, the usefulness of the kayak is decreasing as the ways of making a living are changing through new social developments. The only recent "invention" that Greenlanders have been able to introduce into their hunting profession is the motor boat which, as a mother ship with

one or more kayaks on board, has extended the hunter's operational radius, perhaps warding off the danger of being crowded out of certain hunting grounds undergoing urbanisation.